

DISPENSING VALVE

MODEL VMP30H

◀INSTRUCTION MANUAL▶

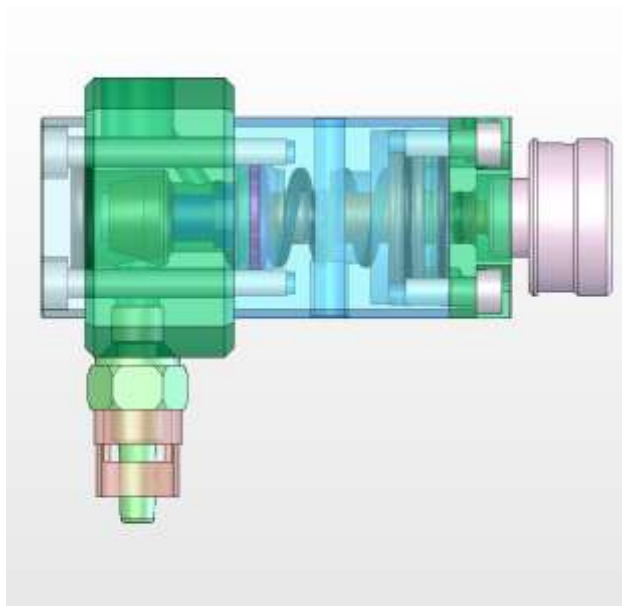

15 Corporate Drive, Suite E - Wayne - NJ 07470
Tel: (973) 646-5044 E-mail: info@fisnar.com
www.fisnar.com

THIS PAGE IS INTENTIONALLY LEFT BLANK

CONTENTS

1	Introduction	page 4
2	Specifications	page 4
3	Overview	page 5
4	Operating Principles	page 6
5	Operating Procedure	
	5-1 Setup	page 7
	5-2 Maintenance	page 9
	5-3 Notice for Use	page 10
6	Sectional Drawing & Dimensions	page 11
7	Exploded View & Parts List	page 12

1. INTRODUCTION

The VMP30H is a multipurpose, mini-poppet pneumatic valve.

This valve can dispense low-mid viscosity to mid- high viscosity materials.

The VMP30H valve has a "Suck-back effect". This eliminates lumping at the end of needle after dispensing (Silicone, RTV, Epoxy, Adhesive kind of rubber, Grease, liquid containing filler). A diaphragm located between driving parts and dosing parts increases the valve life and reduces valve maintenance.

2. SPECIFICATIONS



Operating Air Pressure	3.5~6.0kgf/ cm ² (60~90PSI)
Material Delivery Pressure	Max 6.0kgf/cm ² (90 PSI)
Cycle Rate	300cycles/min (In case of full stroke)
Minimum Shot Size	0.01cc
Flow Rate (KV value)	MAX 1.2ℓ/min
Valve Structure	Poppet type
Weight	162g (5.7oz)
Driving Part Materials	Body: AL Hard Anodizing (Black) Piston: SUS303 Piston Seal: NBR
Wetted Part Materials	Chamber: SUS303 CAP: SUS303 Diaphragm: UHMW-PE Valve Seat: UHMW-PE O-Ring (CAP): Viton
Connecting Ports	Operating Air Inlet: M5*P0.8, ø4 Urethane Hose Material Inlet: BSPT1/8" Material Outlet: Luer Lock type

3. OVERVIEW

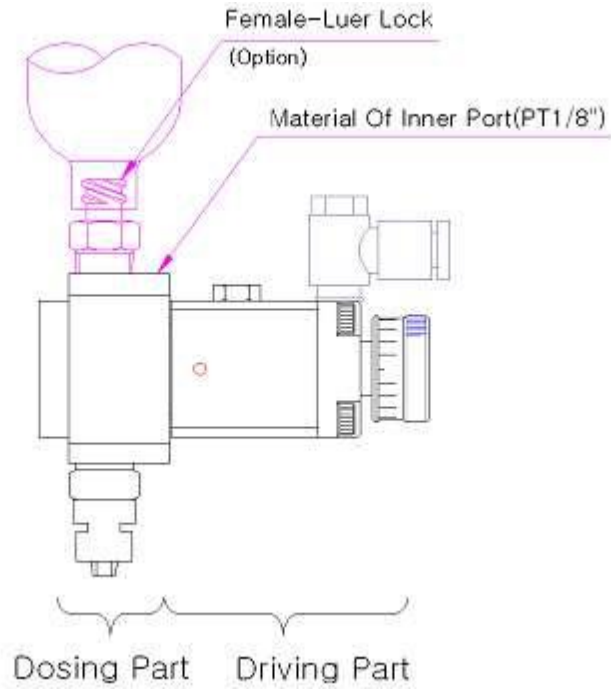
[VMP30H]

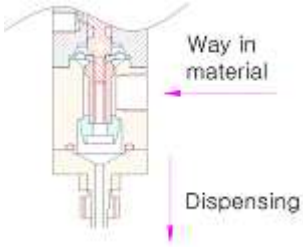
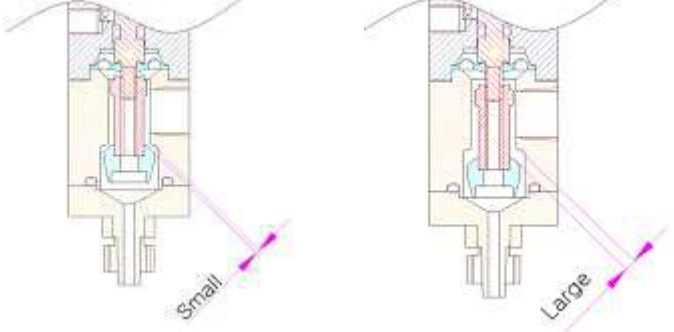

4. OPERATING PRINCIPLES

Dispensing OFF	Dispensing ON							
		<table border="1" data-bbox="815 401 1100 499"> <tr> <td>short</td> <td>Stroke</td> <td>long</td> </tr> <tr> <td>small</td> <td>Shot Volume</td> <td>large</td> </tr> </table> 	short	Stroke	long	small	Shot Volume	large
short	Stroke	long						
small	Shot Volume	large						
								
<p>In the "Normal" state (air off), the diaphragm is closed – material is not dispensed.</p>	<p>When air is applied, the valve seat is opened and material is dispensed.</p>							
<p>Because "Air" is not entering into the driving parts, the diaphragm's needle and valve seat are closed. In this case, the material path is closed, so material is not dispensed.</p>	<p>If you input the air to the driving part, the valve seat will drop according to the shot volume control knob. At this time material will be dispensed.</p> <p>You can increase or decrease the shot volume by adjusting the stroke (shot volume control knob).</p> <p>⚠ Notice</p> <p>The maximum stroke length is 1 mm(2rotations).</p> <p>There is no effect after turning the knob (2) or more rotations.</p> <p>Fix the stroke by tightening the set screw after set-up.</p>							

5. OPERATING PROCEDURE

5-1. Setup

►example for general installation

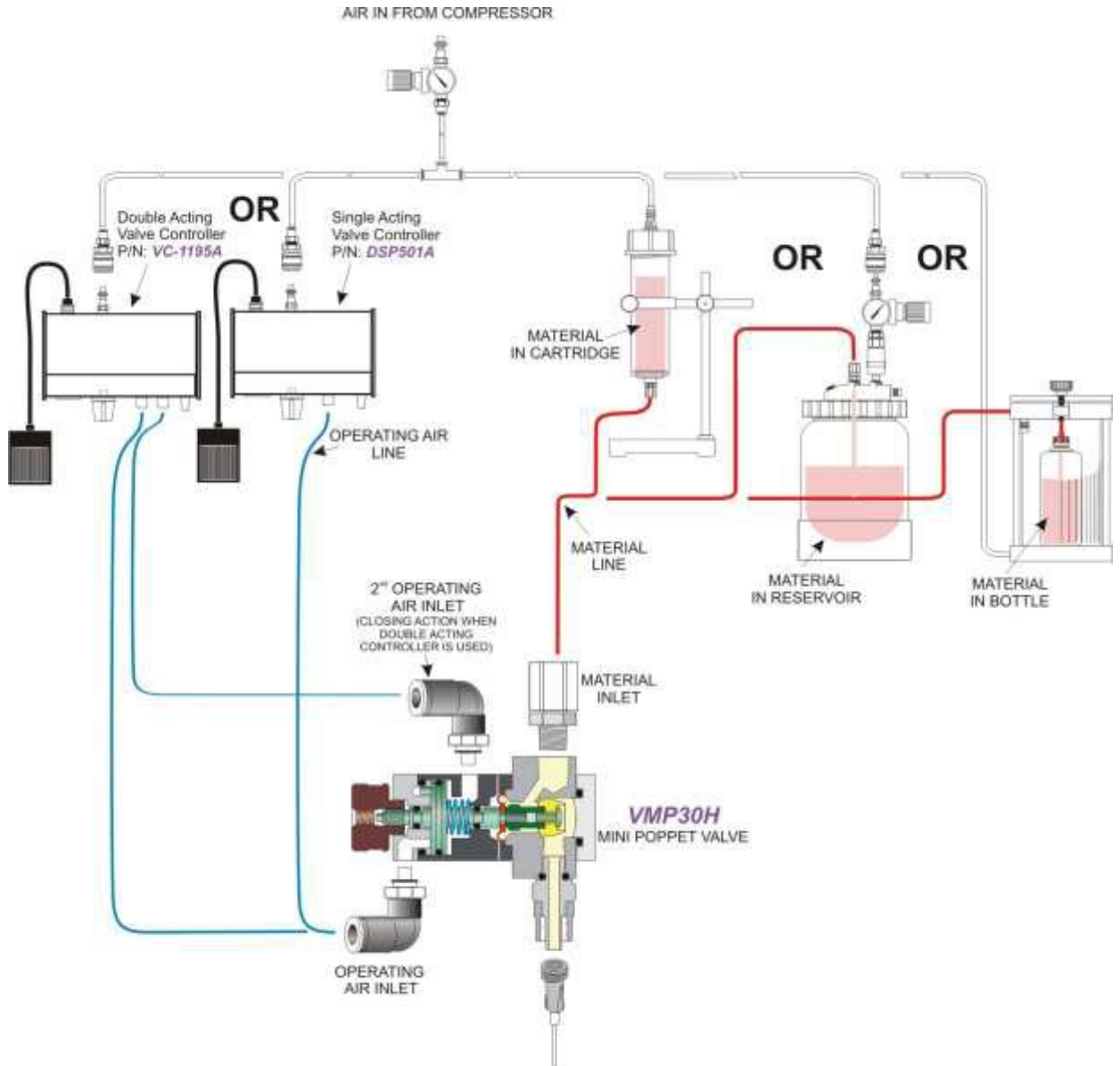

5-1-1)

Fasten the valve firmly using mounting hole (2- \varnothing 3.5*P16).

5-1-2)

Connect air Hose to Air in Port controller.

Valve driving pressure is Min 4.0kgf/cm² or more.

 **Notice**

If the valve uses the built-in spring to close it is classified as single-actuating type.

If the closing speed of single-actuating valve is too slow, change to a double-actuating setup.

*refer to 5-1.Setup

5-1-3)

Connect fitting for material supply hose to the inner port (BSPT1/8").

Connect a suitable sized needle to the outer port (BSPT1/8").

5-1-4)

Set the shot volume using the shot volume control knob, then lock the position by tightening the set screw.

 **Important**

The "Suck-back effect" occurs when the valve is closed. This suck-back effect occurs because of the volume change as valve seat moves up.

"Suck-back effect" will be effected by the material viscosity, material delivery pressure and stroke length.

That is, .

Suck-back effect ↓	∝	-material viscosity ↑
	(is proportional)	-material delivery pressure ↑
		-stroke size ↓

5-1-5)

It's possible to change the position of Air in Port and Material in Port with 90° adapter.

5-2. Maintenance**5-2-1) Cleaning**

- ① Wash valve thoroughly after using if dispensing liquid which has a tendency to be harden or to damage the wetted parts.
- ② Dispense all liquid entirely from pressure container, liquid supply hose
And wetted parts until sufficient air comes out.
- ③ Wash the inside of the valve with a small amount of the proper solvent.
- ④ Wash thoroughly, alternating between air→solvent→air→solvent.

5-2-2) Disassembly

- ① When disassembly is required for cleaning or replacing parts, refer to "7.Exploded View & Parts List".
- ② Disassemble chamber cap by unbinding 4 bolts using L (hexagonal) wrench(#2.5).
- ③ Disassemble "Valve Seat" with L (hexagonal) wrench(#2)
- ④ Disassemble chamber.
- ⑤ Disassemble "Rod" with spanner(#6).
- ⑥ Disassemble diaphragm.

5-2-3) Assembly

Reverse the "Disassemble" instructions above. See additional assembly notes below:

① Install the valve seat and fasten with L (hexagonal) wrench after inserting bolt.

First remove the shot volume control knob as shown in the picture. Fasten by turning the L(hexagonal) wrench slowly 4mm.

② It's possible to change the position of cylinder body, Air in Port and Material in Port with 90° adapters.

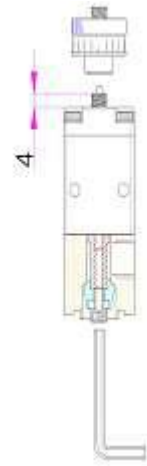

③ Be sure to install the Valve Seat in the correct orientation.

Fasten firmly using L (hexagonal) wrench(No.2)

5-3. Notice for Use

① When disassembling or assembling, be careful not to damaged the valve seat. If the valve seat is damaged, material will leak from the valve.

② If there is an air bubble between the inner port and outer ports, or if there is air in the material itself, it will be more difficult for the valve to close and the Suck-back effect is reduced.

Remove air from the material before using the valve.

③ Bleed air from the valve by dispensing continuously at low material pressure, with the valve pointed upward, before placing in production.

6. SECTIONAL DRAWING & DIMENSIONS

► VMP30H

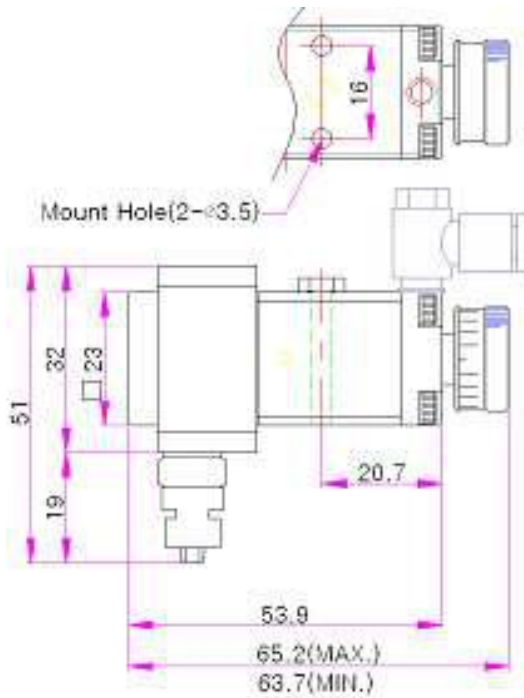
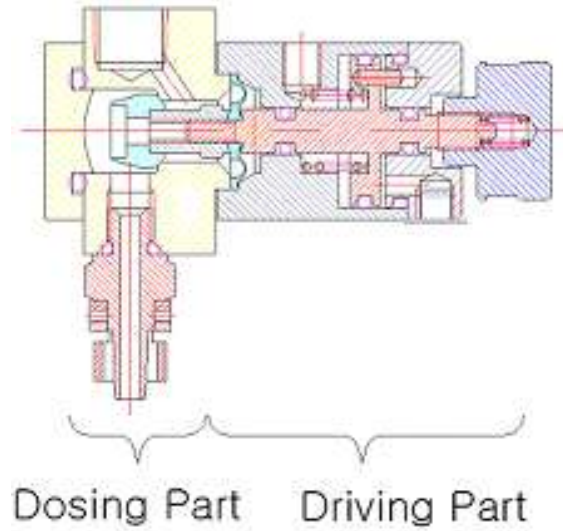

7. EXPLODED VIEW & PARTS LIST

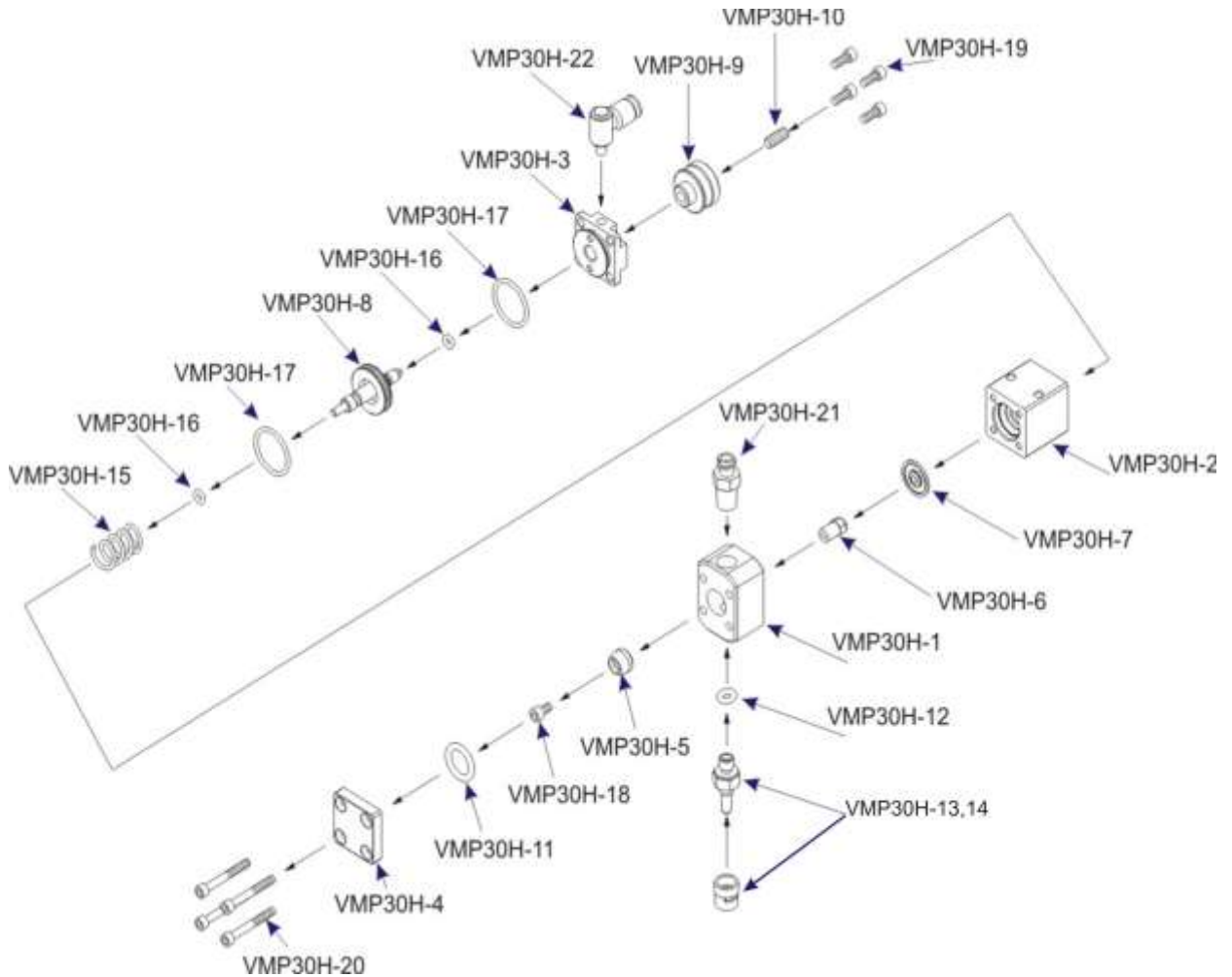

Part Number	Description	Q'TY	Part Number	Description	Q'TY
VMP30H-1	CHAMBER	1	VMP30H-12	O-RING (P4)(VITON)	1
VMP30H-2	CYLINDER BODY	1	VMP30H-13,14	NEEDLE ADAPT & COLLAR	1
VMP30H-3	CYLINDER CAP	1	VMP30H-15	SPRING	1
VMP30H-4	CHAMBER CAP	1	VMP30H-16	O-RING (P3)(NBR)	2
VMP30H-5	VALVE SEAT	1	VMP30H-17	O-RING (AN016)(NBR)	2
VMP30H-6	ROD	1	VMP30H-18	BOLT (M3*8)	1
VMP30H-7	DIAPHRAGM	1	VMP30H-19	BOLT (M3*8)	4
VMP30H-8	PISTON	1	VMP30H-20	BOLT (M3*30)	4
VMP30H-9	CONTROL KNOB	1	VMP30H-21	BARREL ADAPTER	1
VMP30H-10	FIXING SCREW	1	561964	ELBOW FITTING	1
VMP30H-11	O-RING (P11)(VITON)	1			



15 Corporate Drive, Suite E - Wayne - NJ 07470
Tel: (973) 646-5044 E-mail: info@fisnar.com
www.fisnar.com